



■ 2020 WHITE PAPER

APPLYING VRF SYSTEMS IN COLD-CLIMATE APPLICATIONS



INTRODUCTION

Building owners and specifiers can experience design flexibility, **reduced operational costs** and reliable, energy-efficient comfort year-round with Variable Refrigerant Flow (VRF) systems even in extreme cold climates.

Modern VRF systems far exceed the capabilities of conventional heat pumps at low outdoor ambient temperatures. They are positioned to replace fossil-fuel burning equipment in almost any climate.

This White Paper discusses best practices and current technologies for solving derating challenges and applying VRF systems in cold climates.

VRF FUNDAMENTALS

VRF technology consolidates heating and cooling into one, all-electric system. Improving on the direct-expansion (DX) principle, a VRF system uses linear expansion valves (LEV) and an INVERTER-driven compressor to cycle refrigerant and transfer heat between its outdoor unit and the indoor unit(s) in each zone. Continuous communication between the system's outdoor units, indoor units, sensors and controls allow VRF systems to modulate capacity based on loads and occupancy. With precise management of capacity, VRF systems reliably maintain each zone's set point without the noisy and energy-intensive start/stop cycles of conventional systems.

ALL-ELECTRIC ZONED COMFORT

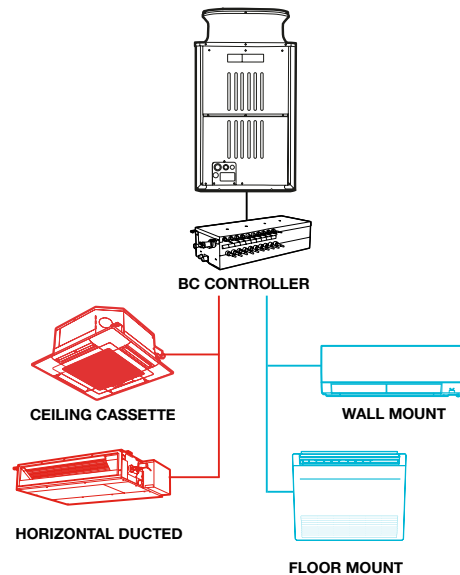

When in heating mode, the outdoor unit introduces heat drawn from ambient air or a nearby water source. When in cooling mode, the indoor units act as evaporators and send heat to the outdoor unit, where it's rejected. If the VRF system is equipped with a branch circuit controller, it can also provide simultaneous heating and cooling by using heat recovery to transfer heat from zones requiring cooling to zones requiring heat.

Heat-recovery systems are typically installed in buildings with multiple zones and diverse thermal profiles such as office buildings, hotels and multifamily applications. VRF **heat-pump systems** are used for single-zone applications or multi-zone applications where each zone has the same thermal profile.

CLIMATE ZONES

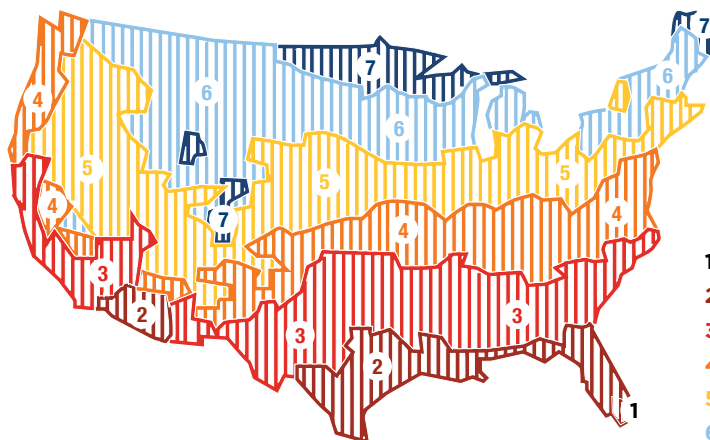

- 1 = Hot/humid winter
- 2 = Warm winter
- 3 = Mild winter
- 4 = Mixed winter
- 5 = Cold winter
- 6 = Very cold winter
- 7 = Extremely cold winter

Source: U.S. Department of Energy

DESIGN CONSIDERATIONS FOR LOW-AMBIENT HEATING

The reliable performance and energy efficiency of modern VRF systems aren't solely the product of superior product engineering. Trade expertise, as reflected in accurate load calculations, proper installation, diligent commissioning, and regular maintenance, is essential for the success of any VRF application, and particularly important in cold-climate applications. Let's discuss six options HVAC contractors and engineers can use to solve derating challenges, even in climate zones 5 and 6.

OPTIONS FOR SOLVING DERATING CHALLENGES



1. VRF flash-injection technology
2. Auxiliary heat
3. Sole-source sizing based on heating
4. Oversize DOAS heat
5. Install outdoor units inside
6. Water-source VRF systems

OPTION 1: VRF FLASH-INJECTION TECHNOLOGY

As long as an air-source heat pump can make its refrigerant cooler than the outdoor air, it can extract thermal energy and deliver it to interior zones as heat. In extreme cold, the compressor needs to operate at speeds much higher than usual to maintain discharge pressure and the necessary refrigerant temperature to capture ambient heat. With flash-injection technology, a VRF system injects a small amount of mixed-phase refrigerant to cool the compressor and allows it to perform at higher speeds without failing due to friction and heat build-up. This method enables VRF systems to deliver significant heat at low temperatures. For example, **CITY MULTI® VRF systems** with Hyper-Heating INVERTER® (H2i®) technology can provide up to 100 percent of heating capacity down to -4° F, 70 percent of heating capacity down to -22° F and continuous heating at temperatures as low as -31° F.

Flash-injection technology creates the opportunity to size units based upon heating loads and use the VRF system as a sole source for heating. In most regions, changeover to auxiliary heating sources will be rare, if necessary, at all.

VRF FLASH-INJECTION DIAGRAM: HEAT PUMP

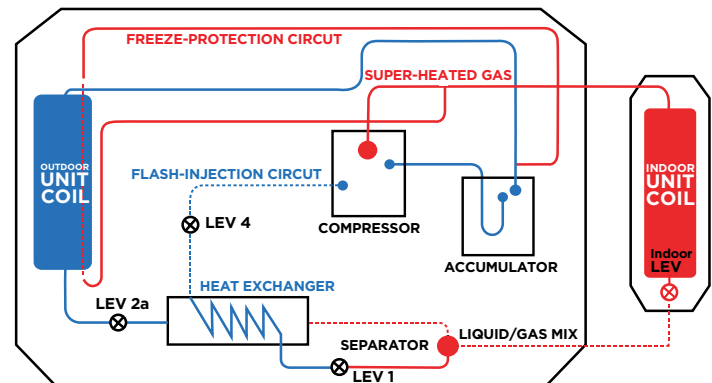

Diagram Guide

The outdoor unit's compressor sends super-heated gas refrigerant to the indoor unit.

The indoor unit LEV controls subcooling through the coil sending heat from the refrigerant to the space and returning a liquid/gas mixed-phase refrigerant back to the outdoor unit.

The liquid travels toward LEV 1 while the gas follows the dotted line to the heat exchanger.

The liquid travels through LEV 1 and the heat exchanger, where it absorbs heat from the gas, and then travels to LEV 4.

At LEV 4, the system meters the mixed-phase refrigerant so that the compressor only receives the amount of refrigerant needed to cool it and prevent overheating at high speeds.

OPTION 2: AUXILIARY HEAT

Auxiliary or backup heat can be provided by a system that generates heat using a different method than the VRF system, such as electric resistance, baseboard hydronic wall-fin radiant heat or duct coils mounted downstream of an air handler. Some systems might be installed with the VRF system for additional peace-of-mind while others might be an older system, such as a gas-fired hydronic boiler a facility repurposes after a retrofit. Due to greater efficiency, the VRF system typically provides the first stage of heat. A gas-fired furnace or boiler, for example, can't exceed an equivalent coefficient of performance (COP) of 1, while VRF systems regularly achieve COPs of 3 and higher. In facilities with district heat, the VRF system can provide the second stage of heat.

The VRF controls can be used to **manage third-party auxiliary equipment** and coordinate changeover according to the space-by-space or global method. Outdoor units (ODU) can interface with and enable supplemental and auxiliary heat sources using indoor board connectors (IBC).

ACTIVATED PER CHANGE IN ZONE TEMPERATURE

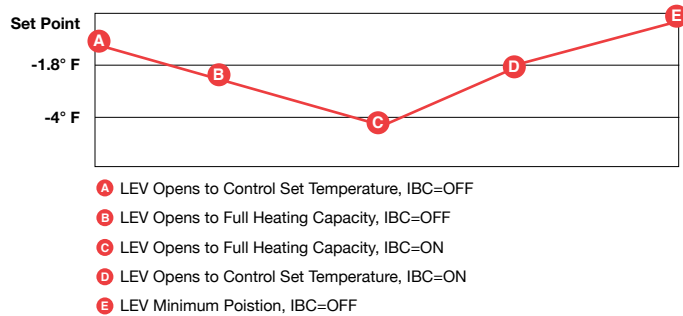

Diagram Guide

<p>At point A, the VRF system is maintaining the set point.</p> <p>At point B, the temperature in the zone starts to drop.</p> <p>Auxiliary heat activates at point C which is -4° F below set point.</p>	<p>The temperature starts to rise at point D.</p> <p>At point E, the auxiliary heat shuts off and the VRF system maintains the set point alone.</p>
---	---



ZONE-BY-ZONE METHOD

With this method, each zone operates independently. Some zones might not have auxiliary heat, even if more critical zones do. The available deadband settings are between 2° F and 9° F below setpoint with the default being 4° F below set point. To give the VRF heat pump a chance to heat the space, select a deadband between 3° F to 4° F before activation of auxiliary heat. This will keep the VRF system as the sole source of heat in the zone for as long as possible but also not let the space get too cold before auxiliary heat activates. For example, if the space heating set point is 72° F and the deadband is 3° F, the auxiliary heat would activate at a space temperature of 70° F and below.

Avoid oversizing auxiliary heat. For example, if a ducted VRF system is backed up by a downstream electric heating coil that is too large, the Delta T of each will add together because the VRF heat pump and auxiliary system are run in a series. Used to diagnose heating and cooling issues, Delta T is the difference between return air and supply air temperatures. If the heat pump has a 20° F Delta T, and the electric heater is designed for a 30° F Delta T, there could be a 50° F Delta T, which is too high. A high Delta T will result in short cycling and other issues like poor space temperature control. Consider sizing for the difference between the VRF system's total heating capacity and the space load.

GLOBAL METHOD

With this method, all of the building's zones switch from the VRF system to auxiliary heat at an adjustable ambient temperature. The switch to auxiliary heat is likely to occur before a VRF heat pump has any difficulty maintaining the set points. This method requires an auxiliary heating system sized for the heating load of the building and must include all zones since the outdoor unit turns off at some point.

ACTIVATED PER CHANGE IN OUTDOOR TEMPERATURE

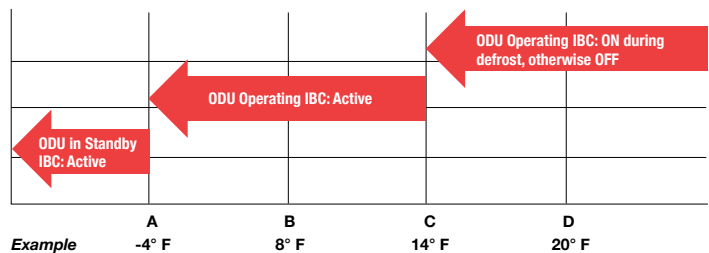

Diagram Guide

<p>The VRF system runs until the ambient temperature is 14° F (point C).</p>	<p>Between 14° F and -4° F (point A), the VRF system runs with the auxiliary heat.</p>	<p>Below -4° F, the auxiliary heat runs alone.</p>
--	--	--

HOW OFTEN DOES AUXILIARY HEAT RUN?

As discussed earlier, if a VRF system incorporates flash-injection technology, auxiliary heat will run infrequently, if at all. It is increasingly common to omit auxiliary heat when applying VRF systems with flash-injection. Also, very few hours of the year are likely to require a VRF system, or any system, to operate at full capacity.

Like all HVAC equipment, VRF systems are sized according to design loads and ASHRAE® design temperatures. VRF systems are up to 40 percent more energy efficient than conventional systems because they vary capacity to precisely match actual loads, but they can provide comfort during the hottest and coldest hours of the year when properly sized.

PARTIAL LOADS ARE PREVALENT

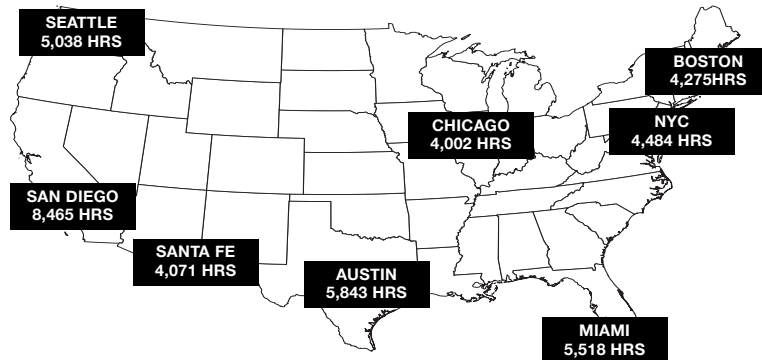

ASHRAE design temperatures usually occur during 1 percent of the hours in a year. During most of a year's 8,760 hours, HVAC systems operate in partial-load heating or cooling conditions between 50° and 80° F. Even in heating-dominated climates, partial loads are prevalent. For example, Chicago, Illinois experiences partial-load conditions for 4,002 hours and Minneapolis, Minnesota experiences partial-load conditions for 3,535 hours, on average.

OPTION 3: SOLE-SOURCE SIZING BASED ON HEATING

As an alternative to using a flash-injection product, there is the option to oversize standard VRF systems for heating capacity. Be mindful of heating derates as found in the VRF manufacturer's selection software or engineering manuals when using this method.

As an example, consider a university building with a winter design temperature of 5° F and a total heating load of 120 KBTU/H. **Which of the following outdoor units would satisfy the heating load?** Nominal heating output for this system is 47° F ambient.

- **Outdoor Unit 1:** Nominal heating output of 188 KBTU/H
- **Outdoor Unit 2:** Nominal heating output of 160 KBTU/H
- **Outdoor Unit 3:** Nominal heating output of 135 KBTU/H

CORRECTION CHART FOR VRF HEAT PUMP 1

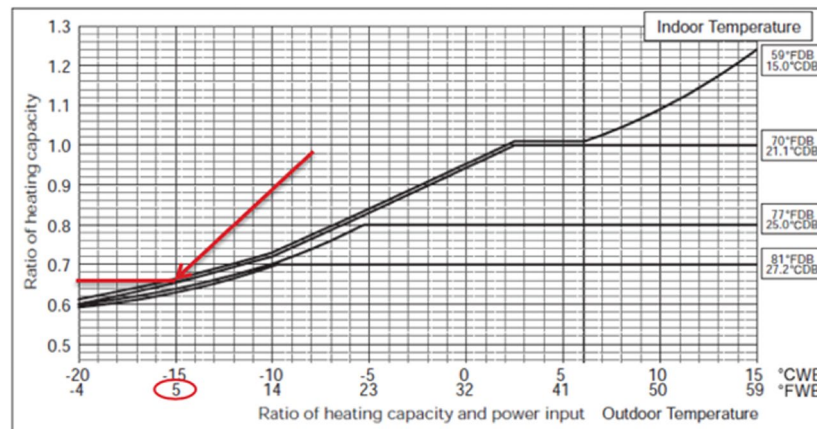

$$188 \text{ KBTU/H} \times 0.65 = 122 \text{ KBTU/H}$$

Look at 5° F on the heating derate chart and observe how the heating output diminishes toward the left. The heating derate is 0.65 at that temperature, so our nominal heating output at 47° F multiplied by 0.65 tells us what the unit will do at 5° F. Outdoor Unit 1 is the best choice since 188 KBTU/H multiplied by 0.65 is approximately 120 KBTU/H.

When using this approach, the designer will likely need to oversize the indoor units as well as the outdoor unit. Otherwise, the indoor units will be unable to use the extra capacity. Oversizing VRF systems to meet heating capacity should be limited to 25 percent or less so that the system doesn't end up being too oversized for the commensurate cooling load. If the required amount of oversizing to meet heating loads is significant, the designer should consider using flash-injection heating outdoor units instead of the standard outdoor units.

OPTION 4: OVERSIZE DOAS SYSTEM

VRF systems are applied with **complementary systems for ventilation**. A dedicated outdoor air system (DOAS) is typically designed to supply room-neutral air (between 70° F and 75° F) but could be upsized to provide additional heat. With the use of a recirculation air damper, the oversized DOAS could be used for emergency heat or morning warmup during winter.



OPTION 5: INSTALL OUTDOOR UNIT INSIDE

To limit derating and weather impacts during severe cold, it's possible to install outdoor units inside the building. In this scenario, air-source condensers are installed in a mechanical room that serves as a recirculation air plenum or a pass-through air plenum, depending on the outdoor temperature. When the auxiliary heat runs, the VRF system's efficiency drops to the efficiency of the backup system. If the unit heater is at 80% efficiency, the COP of the VRF system drops to 0.80. While this approach can be expensive due to the number of dampers and louvers required, it allows a facility to locate auxiliary heat in a central location, the mechanical room.

SAMPLE DESIGN

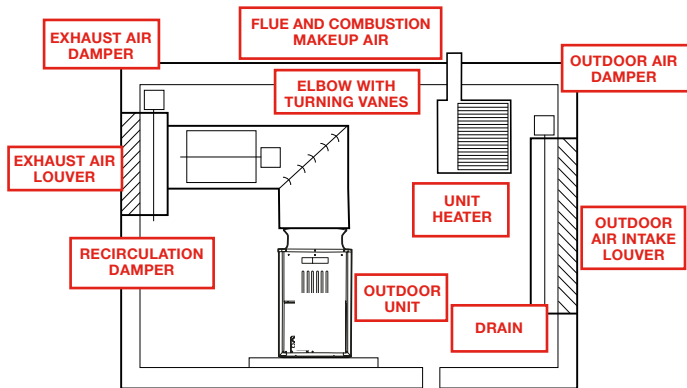

Diagram Guide

Outdoor air intake louver on the right.

Exhaust air louver on the left.

When it's warm outside, both the intake and exhaust louvers are open, and the mechanical room temperature is the same as the ambient temperature.

Outdoor air enters through the intake louver, passes across the condenser coil and goes up through the outdoor unit where the condenser fan pushes the

air through the exhaust air louver and into the ductwork.

At a predetermined colder temperature, the intake air and the exhaust air louvers close.

The recirculation damper opens, turning the mechanical room into a recirculation air plenum.

The auxiliary unit heater activates and heats the mechanical room.

OPTION 6: WATER-SOURCE VRF SYSTEMS

WATER-SOURCE VRF SYSTEM

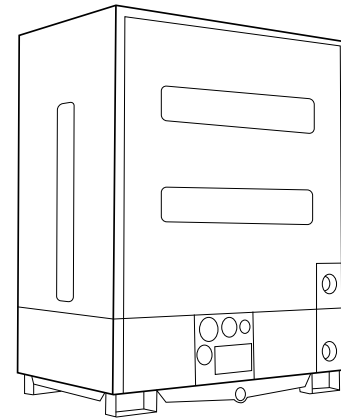

Water-source VRF systems are available as **heat pumps** or with **heat recovery**. With **water-source VRF systems**, all of the equipment is designed to be installed indoors. As with the previous method, the water-source units are protected from the elements, but water-source units also deliver greater efficiency and have less derating. It takes less energy to extract heat or reject heat into or out of water, as compared to air due to the density of each of these mediums. Also, a water loop offers a more defined and controlled temperature range, generally between 60° F and 90° F. The capacity of a water-source system is based on entering water temperature.

SAMPLE WATER-SOURCE SYSTEM DESIGN

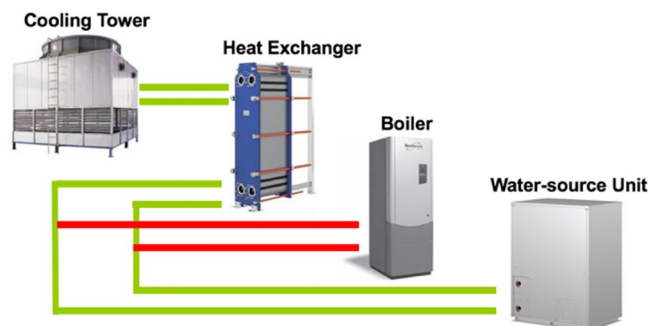

CASE STUDY: FAIRWAY INDEPENDENT MORTGAGE

“ In our past offices, everyone was used to using a space heater in every cubicle. With the way the water-source units are set up on the top floor, they form an outer ring around the entirety of the building. When the skeleton of the building is warm it helps everything else run easier and keep comfortable. The employees here are very happy with the new system. ”

— Arick Fry
Facilities Manager,
Fairway Mortgage



Madison, Wisconsin | 96,000-square-foot, three-story office building | Climate Zone 6 | Water-Source | VRF + Heat Recovery



INSTALLATION CONSIDERATIONS

To protect outdoor units from snow’s impact, install the units at least 12 inches above the maximum expected snow depth. Use a stand with an open design for the base to minimize snow drifting against the unit. Snow hoods and hail guards can protect units from precipitation and improve defrost efficiency. Also, snow hoods can help protect units from icicle damage but be careful installing outdoor units under a drip edge.

Use basepan/panel heaters to prevent ice buildup on the unit caused by condensation produced during defrost. Make sure the water drains away from sidewalks. Consider an area drain to minimize the risk of condensate turning to puddles or ice on a walkable surface near the unit.

In areas subject to high winds, use cables to secure outdoor units to the ground or structure. Cables are particularly important when units are installed on rooftops or any location where winds aren’t obstructed.

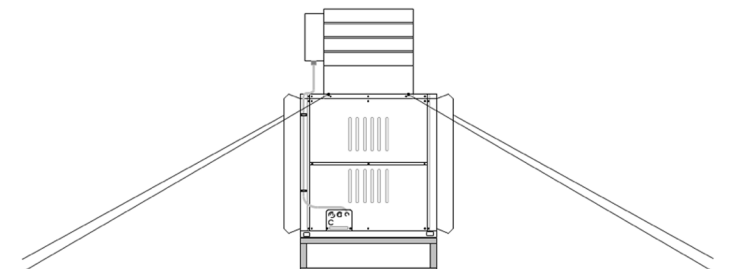

CONCLUSION



If applied according to best practices and consideration for winter weather, modern VRF systems can serve as the primary heating and cooling system in climate zones 1 through 6. With flash-injection compressor technology and water-source options, VRF systems offer cold-climate capabilities far beyond those of conventional heat pump systems, even without auxiliary heat. For more information on designing for cold climates, watch our webinar [Applying VRF Systems in Cold-Climate Applications](#) and visit mitsubishipro.com.